

Surface Panel Downlight

PRLA30078-A

YOUR LOGO
PLACEHOLDER



LAMDA

This fixture can be used in stores and malls, in addition to villas and luxurious apartments, as it distributes the light in an organized way and gives a nice view.

Technical data

Product Model PRLA30078-A	Power 24 W	CRI 70	Voltage 200-240
Beam Angle 120	Light source LED Integrated	IP 20	Product Category Surface Panel Downlight
Working Temperature -20 C° to +40 C°	Lumen 1620	Color Temperature 3000	Adjustability Not Adjustable
Power Factor 0.5	Frequency 50/60	Installation Way Surface	
Lighting Distributor ■ Diffuser-semi transparent-PC		Materials ■ Housing-White-Aluminum	

Applications

Schools, Hospitals & Clinics, Restaurants, Showrooms, Supermarkets, Hotel, Offices, Government institutions

Dimension

Round D295 x H28mm

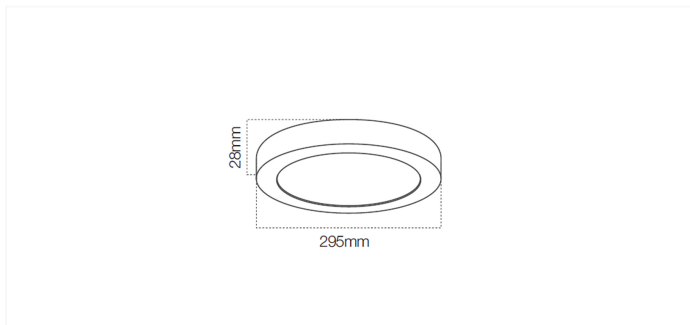

📷 Your logo

demo
佛山市顺德区